



AMERICLAD® AC-94DF
www.americlad.com
866-260-4047

MANUFACTURER:
Quality Metalcrafts, LLC
21925 Industrial Blvd.
Rogers, MN 55374
Telephone: (866) 260-4047
Fax: (763) 255-3399
Email: info@americlad.com

**AMERICLAD
AC-94DF
Louver**

**SECTION 08 90 00
ALUMINUM LOUVER SYSTEM
4" STATIONARY DRAINABLE LOUVER WITH FLANGE
FRAME**

PART 1 – GENERAL

1.1 RELATED DOCUMENTS

- A. The drawings and provisions of the General Conditions, and the sections included under Division 1 specification sections, apply to this section

1.2 SUMMARY

- A. This section includes aluminum louvers

1.3 PERFORMANCE REQUIREMENTS

- A. Performance Ratings: Product must be licensed to bear the AMCA Certified Ratings Seal for water and air performance
 - a. Based on testing 48 inches by 48 inches (1,219 mm x 1,219 mm) size unit in accordance with AMCA 500
- B. Free area: 8.37 square feet, 54%
- C. Water Penetration: Maximum 0.01 ounces per square foot of free area at an air flow of 818 feet per minute free area velocity when tested

1.4 SUBMITTALS

- A. Product Data: Manufacturer's product literature
- B. Finish Samples: submit color samples for final approval



- C. Shop Drawings: submit shop drawings showing plans, sections and details

1.5 QUALITY ASSURANCE

- A. Manufacturer Qualifications: Minimum of five years experience in manufacturing of architectural products
- B. Installer Qualifications: Acceptable to manufacturer
- C. Production Qualifications: Louvers shall be licensed to bear AMCA Certified Ratings Seal Applies to air performance and water penetration ratings

1.6 DELIVERY, STORAGE AND HANDLING

- A. Delivery: deliver louvers in manufacturer's crates packed for long haul transit
- B. Storage: store materials in a dry and safe area
- C. Handling: handle materials to avoid any damage to materials and finishes

1.7 WARRANTY

- A. The contractor must warrant the materials to be free of defects in accordance with the general conditions. Finish warranty shall be extended by paint manufacturer's standard warranty
- B. Manufacturer shall provide a standard limited warranty for louver system for a period of one year from date of installation and no more than eighteen months after shipment from manufacturing plant

PART 2 – PRODUCTS

2.1 MANUFACTURER

- A. Quality Metalcrafts, LLC/AMERICLAD, 21925 Industrial Boulevard, Rogers, Minnesota 55374, Telephone: (866) 260-4047, www.americlad.com
- A. Approved equal submitted for approval 10 days prior to bid

2.2 FABRICATION

- A. Model: AC-94DF Aluminum Louver System, 4" fixed, non-drainable louver with flange frame
- B. Performance Ratings: AMCA Licensed
- C. Frame:
 - a. Depth: 4" (101.6 mm)
 - b. Material: Extruded aluminum 6063-T5
 - c. Wall Thickness: 0.081 inch (2.06 mm), nominal



- d. Downspouts and caulking surfaces
- D. Blades:
 - a. Style: Stationary Drainable
 - b. Material: Extruded aluminum 6063-T5
 - c. Wall Thickness: 0.081 inch (2.06 mm), nominal
 - d. Angle: 37.5 degrees
 - e. Centers 5.062 inches (128.58 mm), nominal

2.3 ACCESSORIES

- A. Aluminum Sill: Provide sill flashing manufactured from same material and finish as louvers where indicated on drawings
- B. Screens: provide framed removable screens for exterior louvers
 - a. Bird Screens
 - b. Insect Screens
 - c. Blank off Panels
 - i. Insulated
 - ii. Non-insulated

2.4 FINISHES

- A. Paint:
 - 1. Coating shall be a Spray Applied Fluorocarbon Resin Utilizing a 70% Kynar 500/Hylar 5000 resin
 - 2. Color as selected by owner from paint manufacturer's standard colors or Custom color as specified
 - 3. Material to be painted in accordance with either AAMA specification 2605 or 2604
- B. Anodized:
 - 1. Class I, Clear Anodic Finish: AA-M12C22A41, mechanical finish, nonspecular as fabricated. Coating to have an anodic coating of 0.7 mil (0.018 mm) thickness
 - 2. Class I, Color Anodic Finish: AA-M12C22A42/A44, mechanical finish, nonspecular as fabricated. Color to be determined by Owner. Coating to have an anodic coating of 0.7 mil (0.018) thickness

PART 3 – EXECUTION

3.1 PREPARATION

- A. Coordinate drawings, diagrams, and instructions for installation

3.2 INSTALLATION



AMERICLAD® AC-94DF
www.americlad.com
866-260-4047

- A. Install louvers at locations as indicated on the drawings and in accordance with the manufacturer's instructions
- B. Install louvers plumb, level, in plane of wall, and in alignment with adjacent work
- C. Install joint sealants as specified in section 07 90 00

3.3 CLEANING AND PROTECTION

- A. Clean exposed surfaces after installation per manufacturer's recommendation
- B. Touch up minor abrasions in finish with touch up paint supplied by finish applicator

END OF SECTION



21925 Industrial Blvd.
 Rogers, MN 55374
 866-260-4047
 www.americlad.com

AC-94DF DRAINABLE STATIONARY LOUVER
 FLANGE FRAME

STANDARD CONSTRUCTION

FRAME

- 4" deep, 6063-T5 extruded aluminum with a .081" nominal wall thickness

BLADES

- 6063-T5 extruded aluminum with a .081" nominal wall thickness
- Blades are positioned at a 37.5° angle and spaced approximately 5.062" centers

SCREEN

- .5" x .051" thick, aluminum flattened expanded metal bird screen in a removable frame
- Screen will add approximately 0.5" to the overall louver depth

FINISH

- Mill Finish

MINIMUM LOUVER SIZE

- 12" wide x 12" high

MAXIMUM LOUVER SIZE

- 70 square feet per section
- Single section size not to exceed 120" wide x 84" high or 84" wide x 120" high
- Louvers exceeding the maximum single section size will be built in multiple sections and require field assembly

BLADE BRACE SUPPORT ANGLES

- Depending on louver size, wind load, or other special requirements, louvers will have rear mounted blade support angles that will increase overall louver depth

Note: Louvers built .25" smaller than opening size given

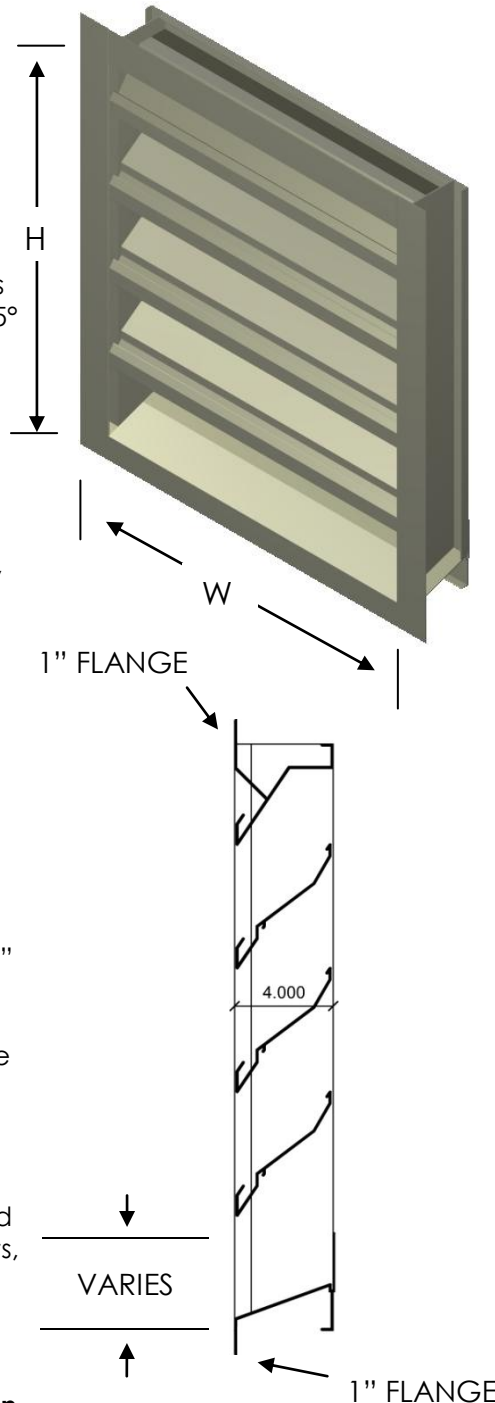

STANDARD FEATURES

- Aluminum construction, providing a high resistance to corrosion
- All welded construction for strength and durability
- 52% Free Area (based on a 48" x 48" unit)
- Drainable head collects and channels water to drainable jamb to provide excellent water penetration performance
- Drainable blade channels water to drainable jamb minimizing water cascade between blades
- Hidden mullions allow for continuous blade appearance up to 120"
- Published performance ratings data based on testing in accordance with AMCA Publication 511

OPTIONS AVAILABLE

Many optional accessories to the basic design are available at an additional cost, including:

- Sill extension/head flashing
- Hinged frame/channel subframe
- Security bars
- Filter rack
- Bird/insect screens (please refer to screen submittal)
- Blank-off panels (standard or insulated)

FINISHES

- Kynar 500/Hylar 5000
- Baked Enamel
- Prime Coat
- Anodized in various colors and shades (some color variation is possible with anodized finishes)

Contact Quality Metalcrafts, LLC / AMERICLAD® for any additional information or any special requirements

AC-94D PERFORMANCE DATA SHEET

WATER PENETRATION

* Beginning point of water penetration is 818 fpm
(Based on 48" x 48" louver)

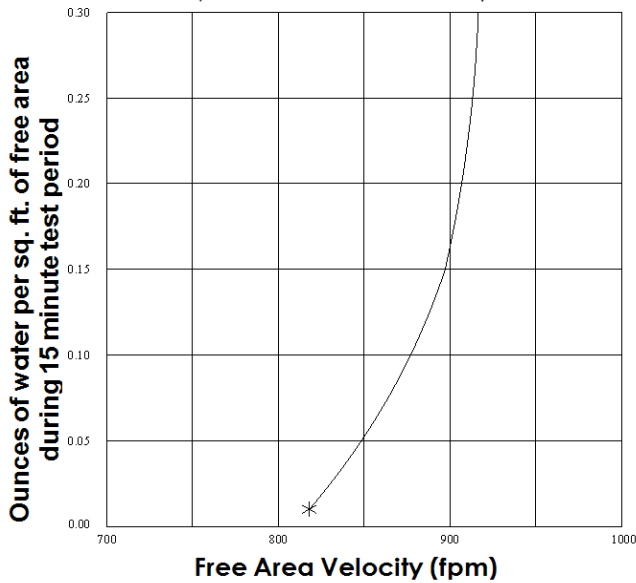

PRESSURE DROP

(Based on 48" x 48" louver)

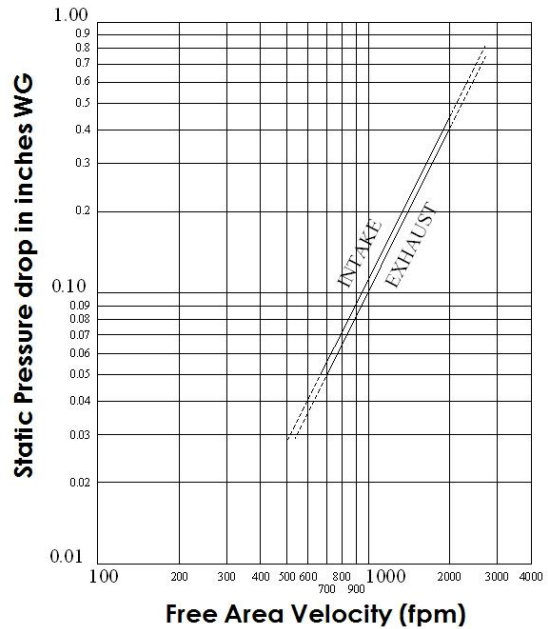

WATER PENETRATION

AMCA defines the beginning point of water penetration as the free area velocity at which 0.01 ounces or less of water per square foot of louver free area is measured to pass through a 48" x 48" louver during a 15 minute period. The AMCA water penetration test provides test data for the comparison of louver designs as to efficiency in resisting the penetration of rainfall under specific laboratory test conditions.

LOUVER SIZE DETERMINATION

_____ cfm / _____ fpm = _____ ft ²
air flow / free area velocity @ / required louver volume / beginning point of water / free area penetration
Select louver size from Free Area Chart below, based on required louver free area above.
Determine pressure drop from Pressure Drop Chart based on required louver free area above.



Quality Metalcrafts, LLC certifies that the product line shown herein is licensed to bear the AMCA seal. The ratings shown are based on tests and procedures performed in accordance with AMCA Publication 511 and comply with the requirements of the AMCA Certified Ratings Program. The AMCA Certified Rating Seal applies to water penetration and air performance ratings for rectangular louvers only.

AC-94D FREE AREA CHART

Free area chart shows square feet of free area of various louver sizes
Free Area AMCA Licensed for openings up to 84" x 120"

H/W	12	24	36	48	60	72	84	96	108	120
12	0.34	0.75	1.16	1.58	1.99	2.40	2.82	3.23	3.65	4.06
24	0.83	1.86	2.89	3.92	4.95	5.97	7.00	8.03	9.06	10.08
36	1.31	2.93	4.55	6.17	7.79	9.41	11.02	12.64	14.26	15.88
48	1.83	4.09	6.35	8.37	10.86	13.12	15.37	17.63	19.89	22.15
60	2.30	5.12	7.95	10.77	13.60	16.43	19.25	22.08	24.90	27.73
72	2.79	6.23	9.67	13.11	16.55	19.99	23.42	26.86	30.30	33.74
84	3.34	7.45	11.56	15.67	19.78	23.89	28.00	32.11	36.23	40.34
96	3.76	8.38	13.01	17.63	22.26	26.88	31.50	36.13	40.75	45.38
108	4.29	9.57	14.85	20.13	25.42	30.70	35.98	41.26	46.54	51.82
120	4.80	10.71	16.62	22.53	28.44	34.35	40.26	46.16	52.07	57.98



AC-94DF

LOUVER - 4 INCH W/ FLANGE

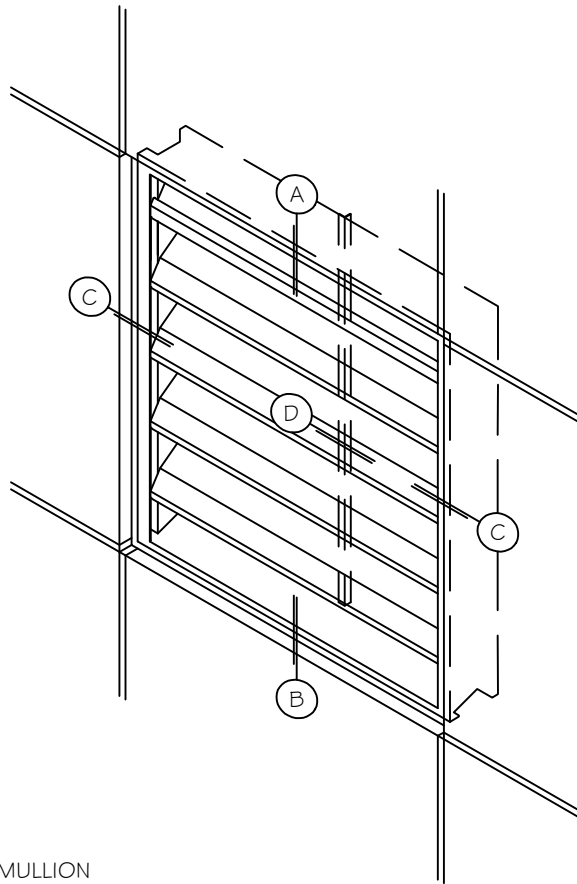

- (A) HEAD
- (B) SILL
- (C) JAMB
- (D) HIDDEN MULLION
- (E) SPECIAL SHAPE LOUVERS

COPYRIGHT QUALITY METALCRAFTS, LLC

21925 Industrial Boulevard · Rogers, Minnesota · Toll-Free: 1-866-260-4047 · americlad.com
Architectural Metal Products



AC-94DF

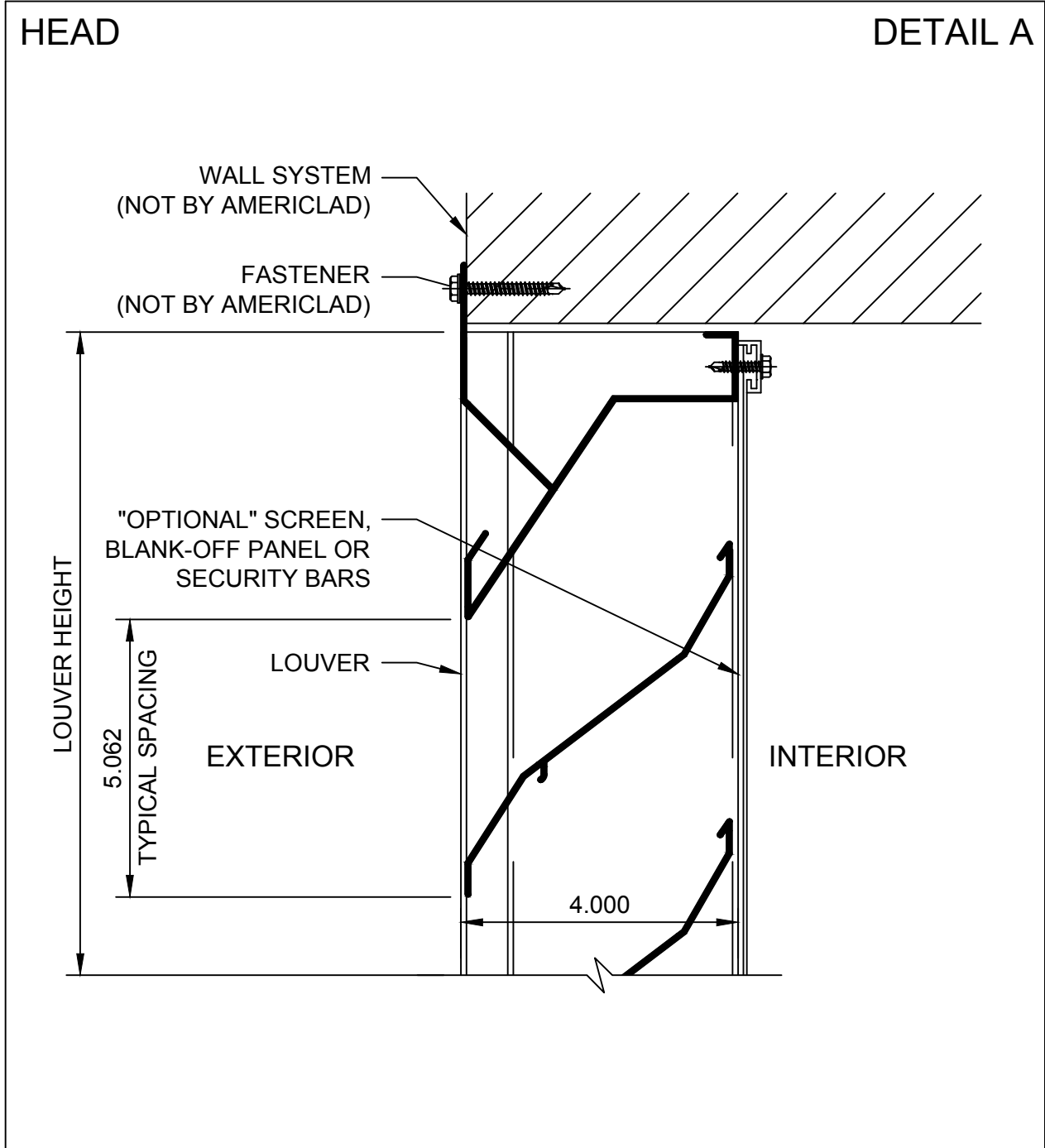

COPYRIGHT QUALITY METALCRAFTS, LLC

21925 Industrial Boulevard · Rogers, Minnesota · Toll-Free: 1-866-260-4047 · americlad.com
Architectural Metal Products



AC-94DF

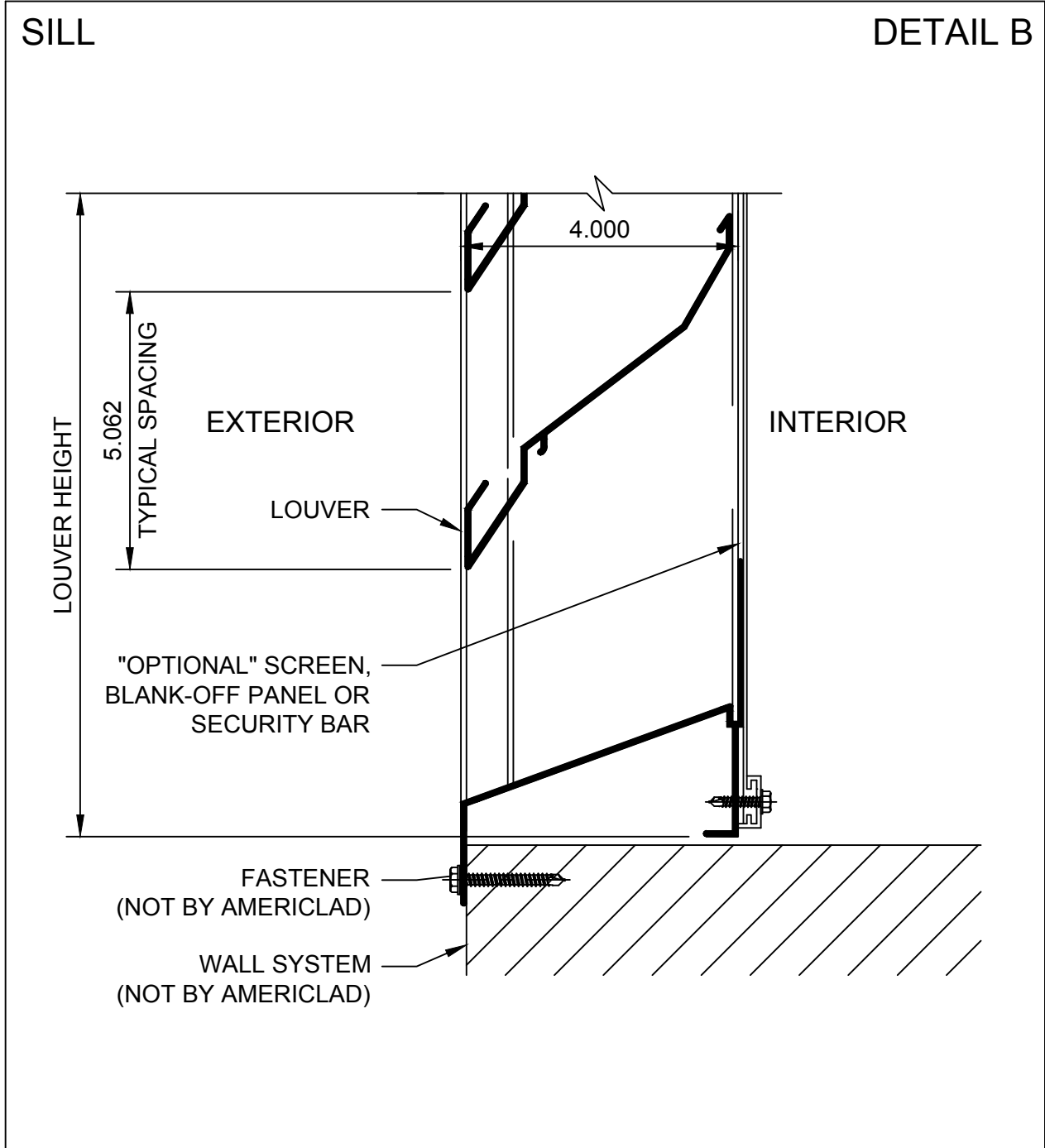

COPYRIGHT QUALITY METALCRAFTS, LLC

21925 Industrial Boulevard · Rogers, Minnesota · Toll-Free: 1-866-260-4047 · americlad.com
Architectural Metal Products



AC-94DF

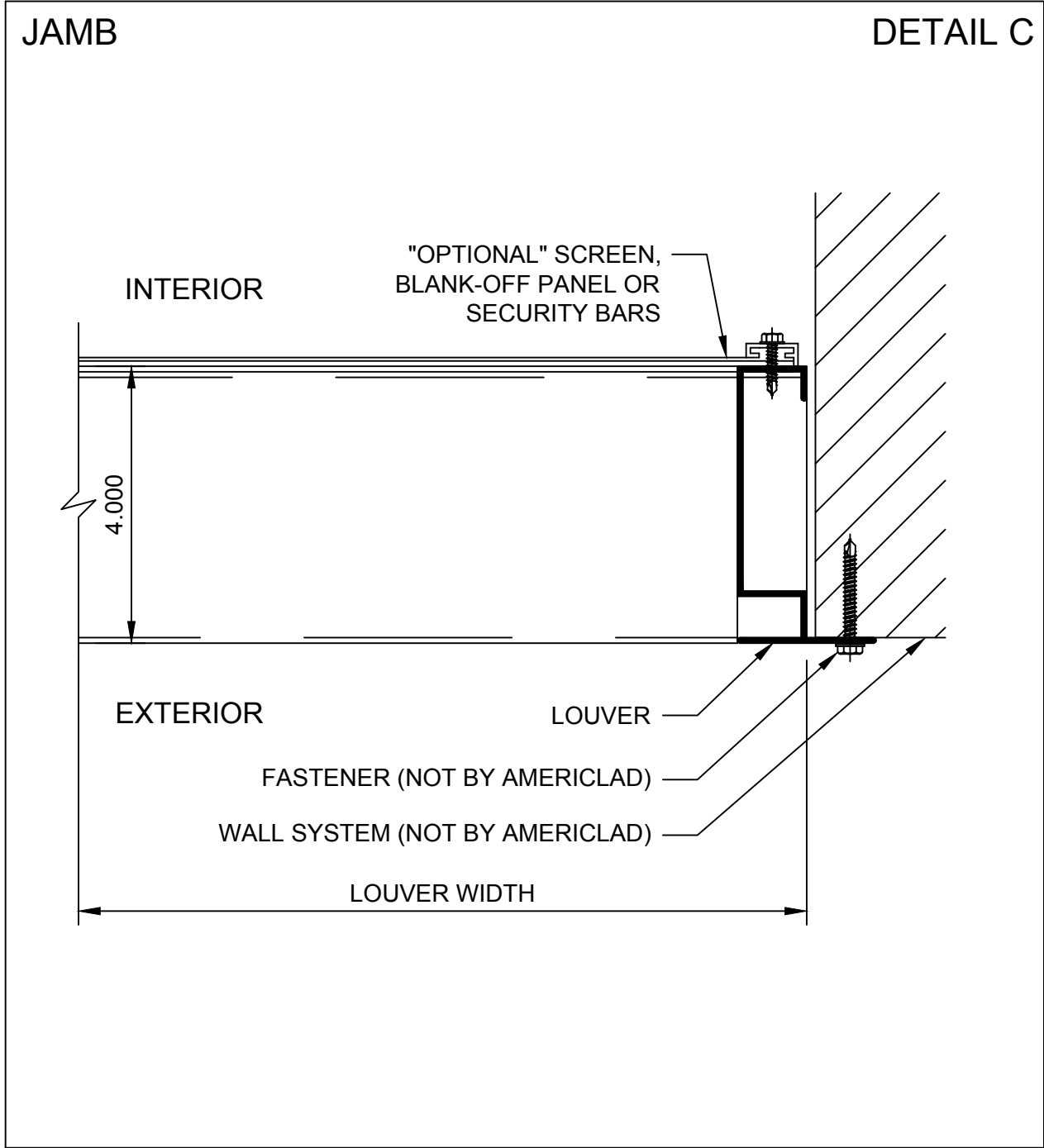

COPYRIGHT QUALITY METALCRAFTS, LLC

21925 Industrial Boulevard · Rogers, Minnesota · Toll-Free: 1-866-260-4047 · americlad.com
Architectural Metal Products



AC-94DF

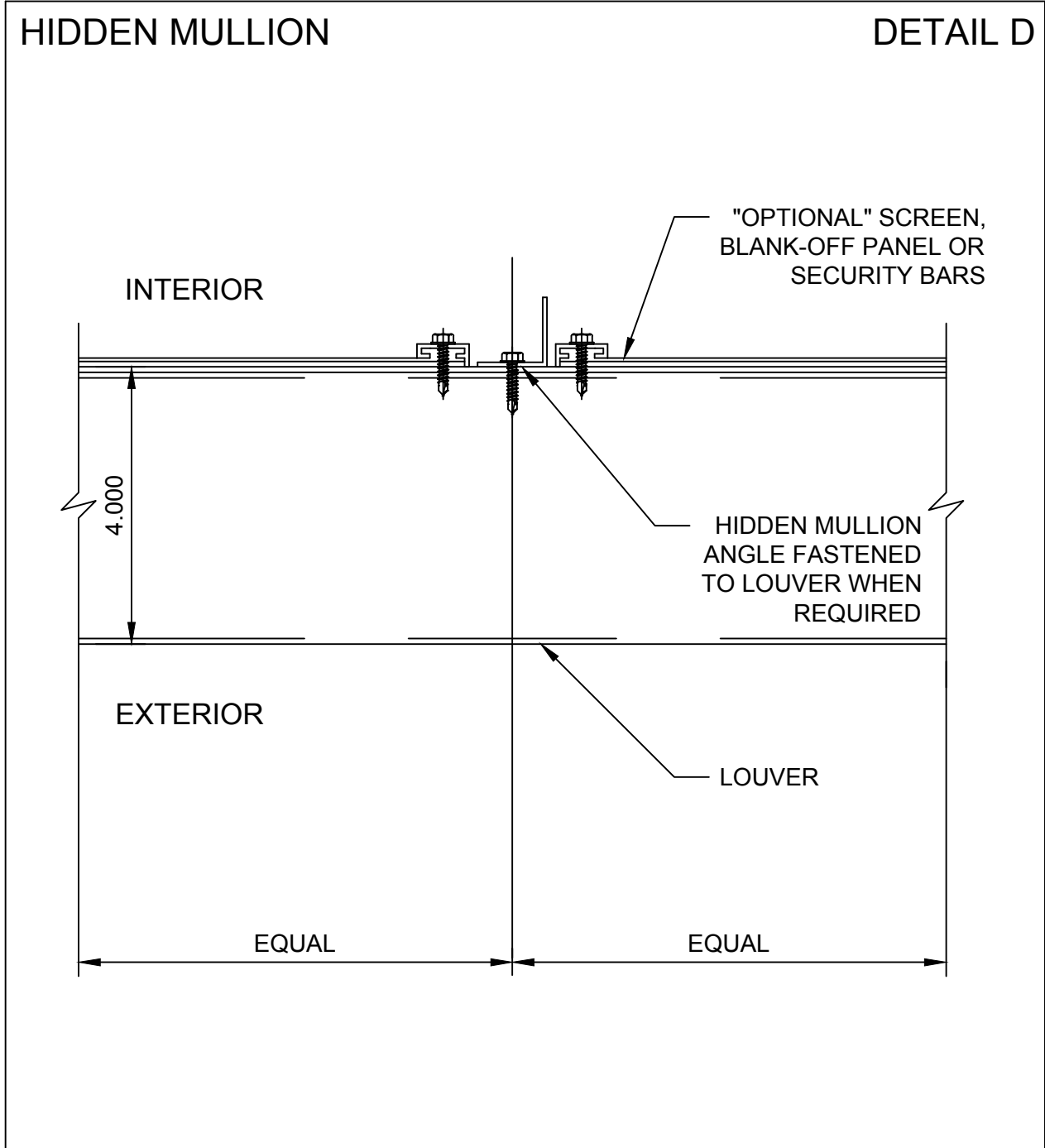

COPYRIGHT QUALITY METALCRAFTS, LLC

21925 Industrial Boulevard · Rogers, Minnesota · Toll-Free: 1-866-260-4047 · americlad.com
Architectural Metal Products



AC-94DF

SPECIAL SHAPE LOUVERS

DETAIL E

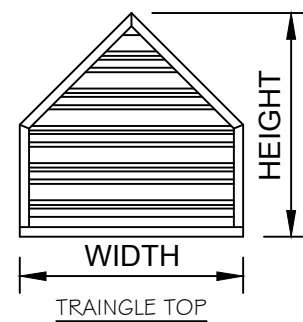
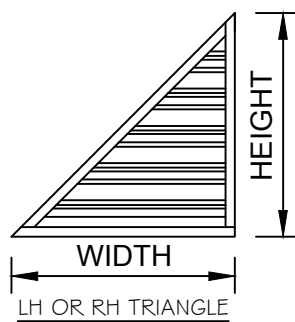
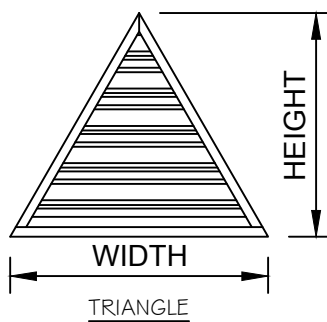
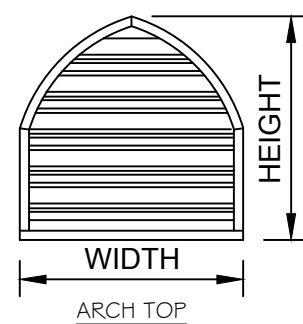
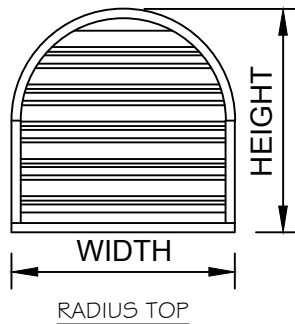
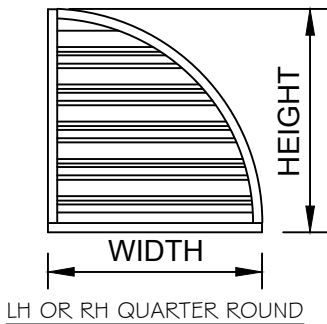
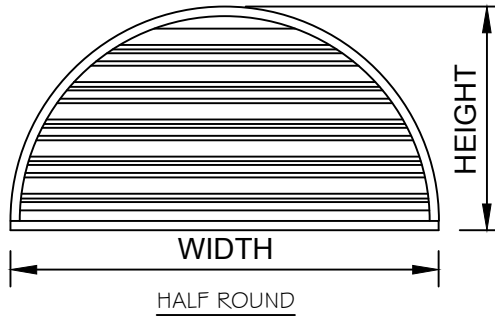
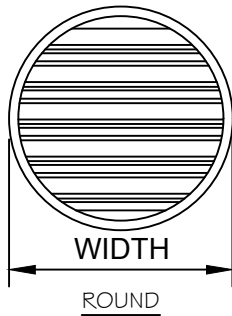

COPYRIGHT QUALITY METALCRAFTS, LLC

21925 Industrial Boulevard · Rogers, Minnesota · Toll-Free: 1-866-260-4047 · americlad.com

Architectural Metal Products